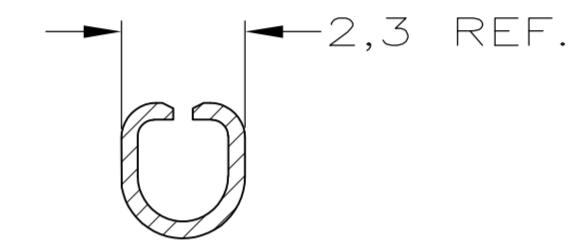
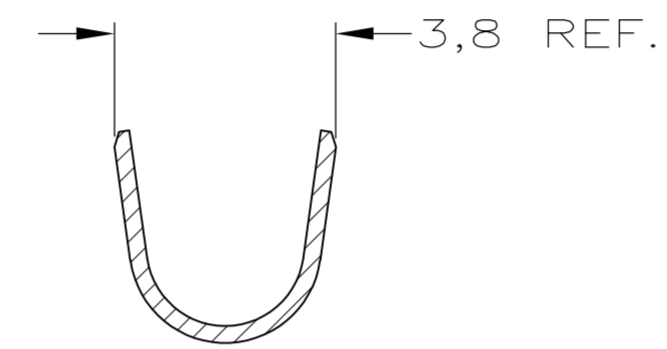
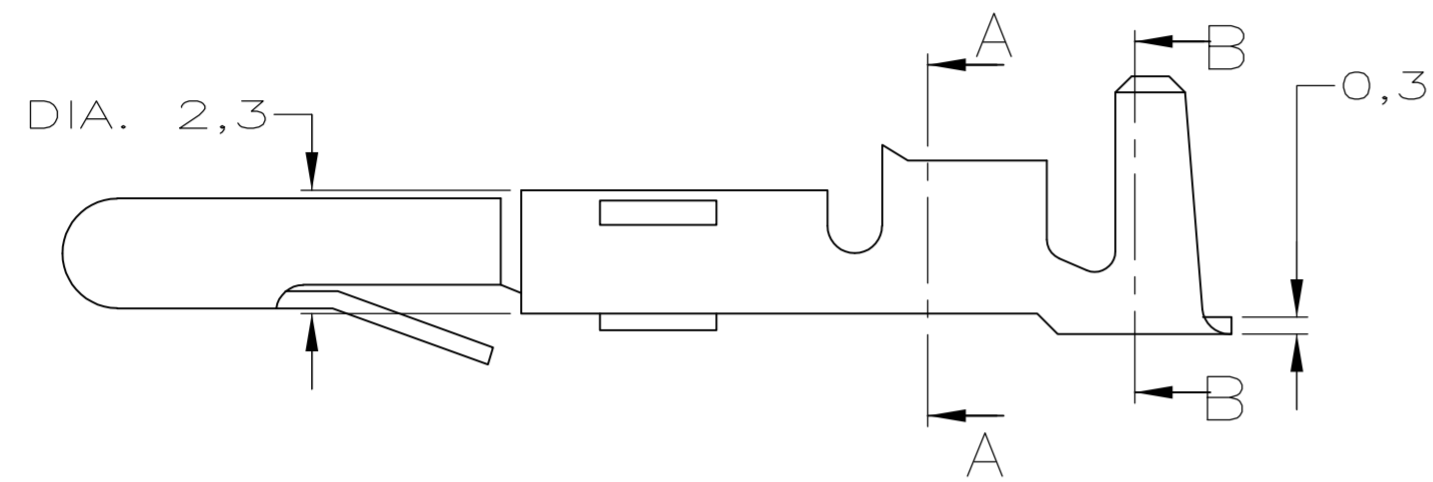
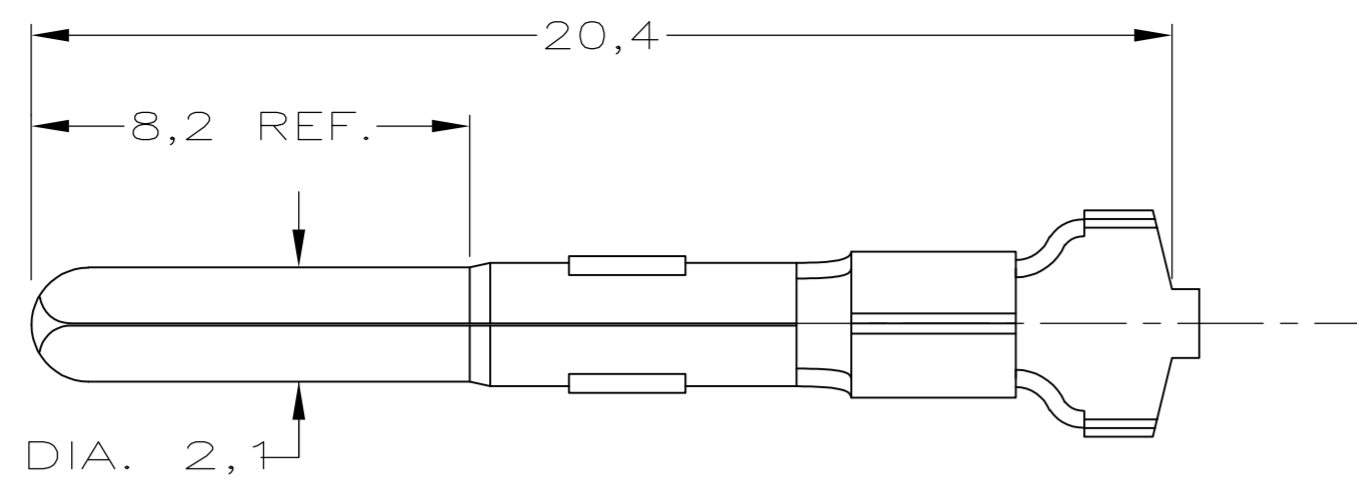
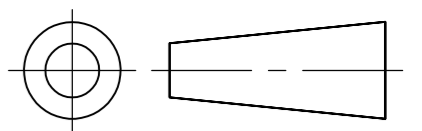

DO NOT SCALE

DIMENSIONS IN mm

METRIC

THIRD ANGLE
PROJECTION

SECTION B-B

SECTION A-A

WIRE RANGE :
1,0-2,5 mm
INSULATION RANGE :
2,9 MAX. DIA.

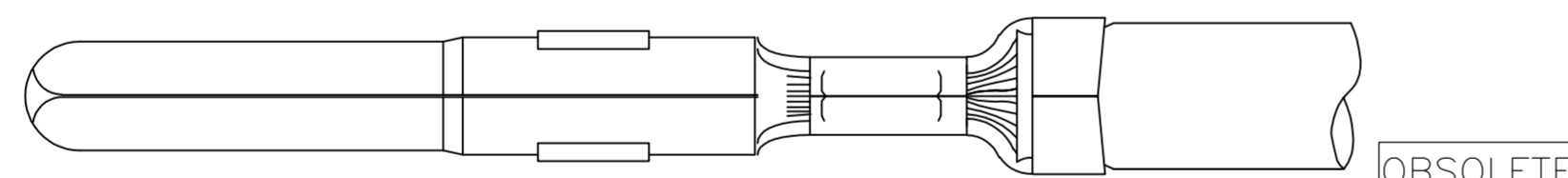
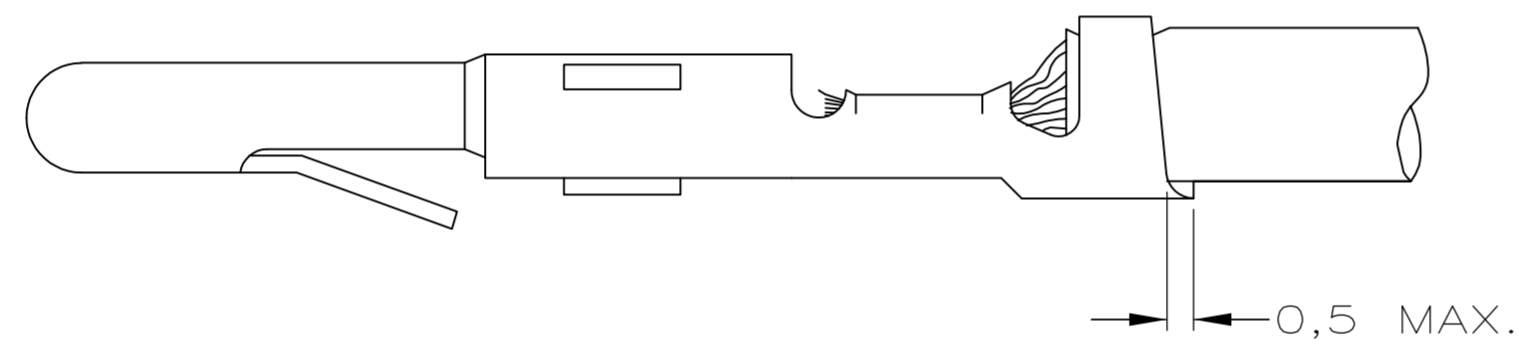

OBSOLETE

1 OBSOLETE

	-	-	-
	-	-	-
	-	-	-
	-	-	-
	-	-	-
	-	-	-
	-	-	-
	-	-	-
	PRE-TINPLATED	PHOSPHOR BR.	163307-4
	UNPLATED	PHOSPHOR BR.	1 163307-3
	PRE-TINPLATED	BRASS	163307-2
	UNPLATED	BRASS	163307-1
	PLATING	MATERIAL	PARTNUMBER

CUSTOMER DRAWING FOR REFERENCE ONLY
WILL NOT BE UPDATED© COPYRIGHT - BY -
ALL INTERNATIONAL RIGHTS RESERVED.THIS DRAWING IS UNPUBLISHED
RELEASED FOR PUBLICATION _____, 19____

TE Connectivity

NAME

PIN MATE-N-LOK.

D2 REVISED PER ECO-11-005294 RK HMR 05APR11

LTR. REVISION RECORD DR. CHK. DATE

DR.: J.v.LIEMPT CHK.: A.BIJNEN. APP.: M.v.DRIEL DWG.No. C-163307
DATE: 24 OCT 96 DATE: - DATE: -REV.LTR. SHEET
D2 1 OF 1 A3